

Quantum Plazma PLM40

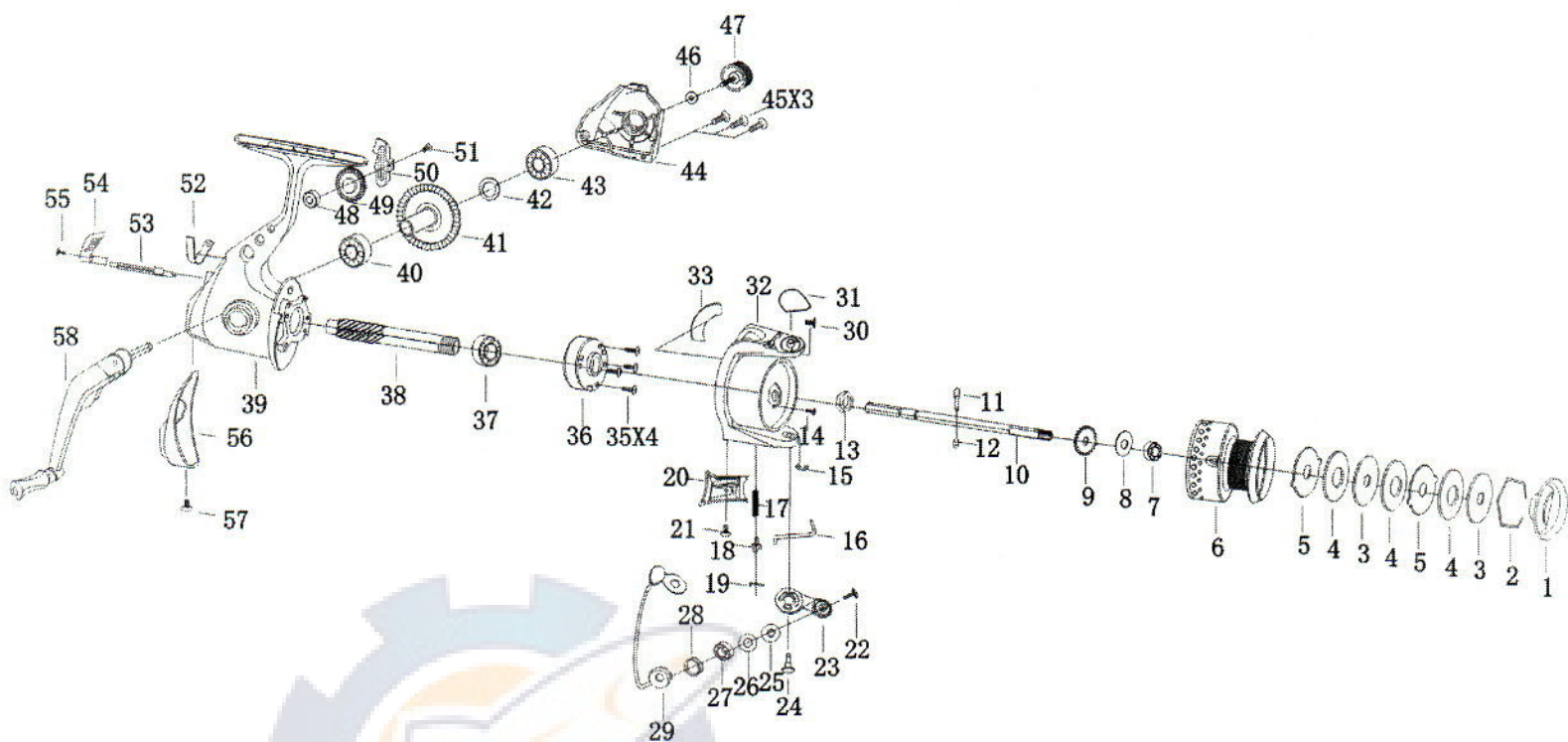

KEY # DESCRIPTION

- 1 DRAG KNOB
- 2 HEXAGON CLIP
- 3 KEY WASHER
- 4 DRAG WASHER
- 5 EAR WASHER
- 6 SPOOL

- 7 BALL BEARING
- 8 CLICK GEAR WASHER
- 9 CLICK GEAR
- 10 MAIN SHAFT
- 11 PIN
- 12 PIN BUSHING
- 13 ROTOR NUT
- 14 SCREW
- 15 E-CLIP
- 16 FLIP WIRE
- 17 SPRING
- 18 FLIP LEVER
- 19 FLIP WIRE
- 20 ARM LEVER COVER
- 21 SCREW
- 22 SCREW
- 23 BAIL ARM
- 24 SCREW
- 25 LINE ROLLER BUSHING
- 26 WASHER
- 27 BALL BEARING
- 28 LINE ROLLER
- 29 BAIL ASSY.

KEY # DESCRIPTION

- 30 SCREW
- 31 BAIL ARM COVER
- 32 ROTOR
- 33 BALANCE WEIGHT
- 34 BUSHING
- 35 SCREW
- 36 ONE WAY CLUTCH ASSY.
- 37 BALL BEARING
- 38 PINION GEAR
- 39 BODY
- 40 BALL BEARING
- 41 GEAR
- 42 GEAR WASHER
- 43 BALL BEARING
- 44 SIDE PLATE
- 45 SCREW
- 46 HANDLE SCREW CAP'S WASHER
- 47 HANDLE SCREW
- 48 OSCILLATION BUSHING
- 49 OSCILLATION GEAR
- 50 OSCILLATION SLIDER
- 51 SCREW
- 52 SPRING
- 53 FLIP LEVER
- 54 ANTI-REVERSE LEVER
- 55 SCREW
- 56 BODY BUTT CAP
- 57 SCREW
- 58 HANDLE ASSY. (INCLUDED TWO BALL BEARINGS)